

LED ON STABILIZER

Wallmounted, standing and hanging
textile LED frame

Colors:



Silver

Available in every color on request.

Application: Wallmount, freestanding,
suspended from ceiling

Width: 4.7 inches (120mm)

Length: Up to 20 feet

Possibilities: Any size possible

Lumen per yd: 5500

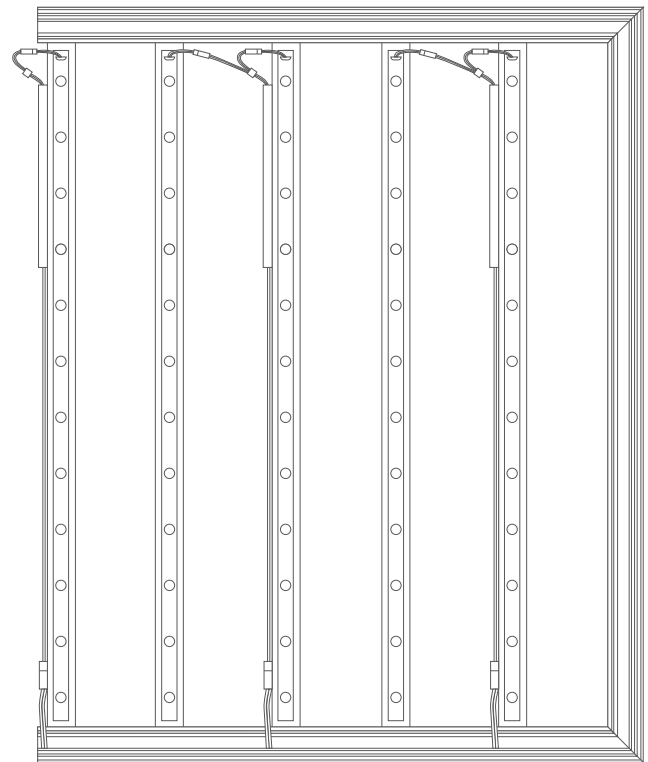
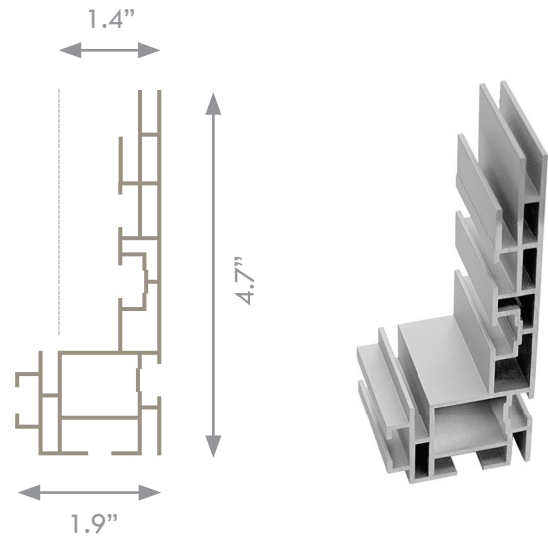

EL 9206-1148



For oversized LED frames, the Brite-LED is mounted on stabilizers, equally spaced for even light distribution.

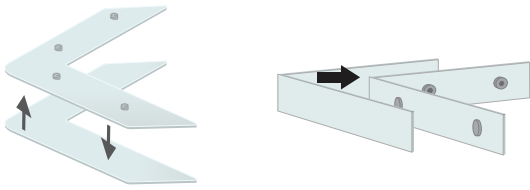

BH0240 / BH0250

Each frame is delivered with 4 locksets heavy and 4 locksets BH0250.

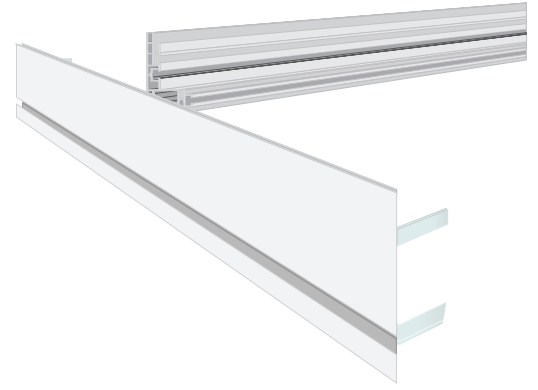

Optional

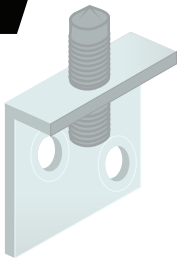

BH0400

These wallmounts can be placed under the frame to hang the frame on the wall.

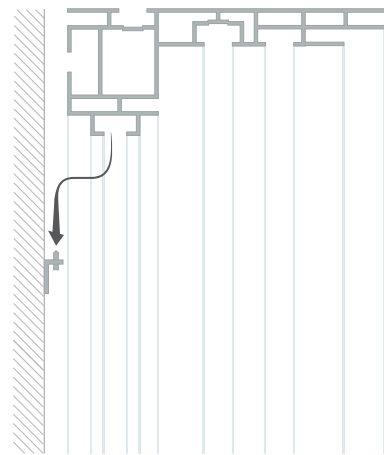

Optional

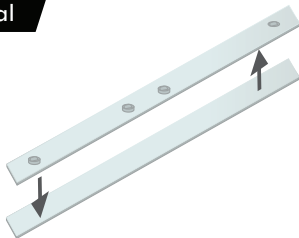

BH0500

If the length of the frame is longer than 13 feet, an extension set (BH0500) is included.

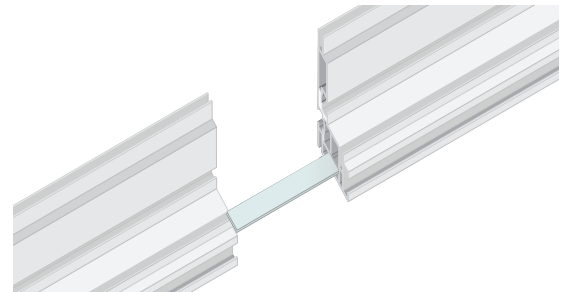

These extension sets can be placed in the channels where the frame is cut in half.

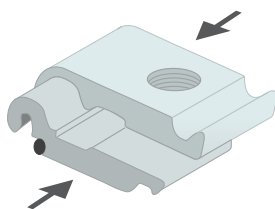

BH0220

When connecting the stabilizer, first place the lockset in the channel.

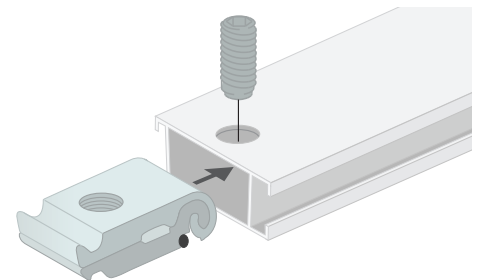

Then put the stabilizer (BFSTS) on the lockset, now tighten the screw with the delivered allen key.

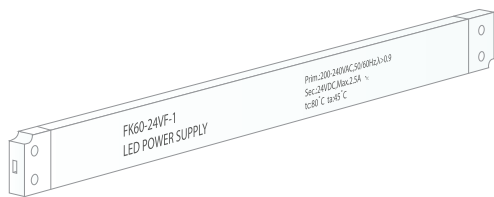

LED POWER SUPPLY
200-240V

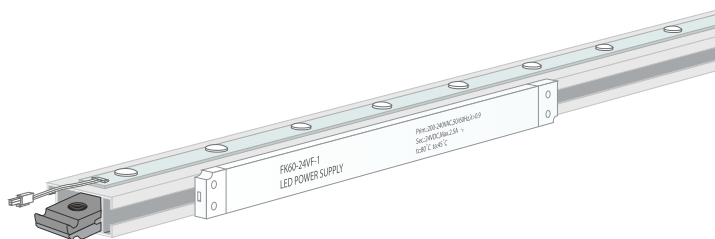

Sec.: 24VDC, Max 2.5A
tc: 80° ta:45°C

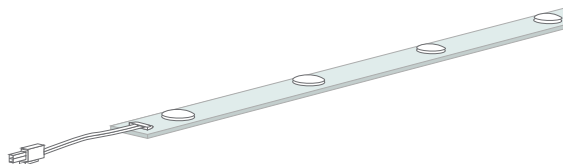
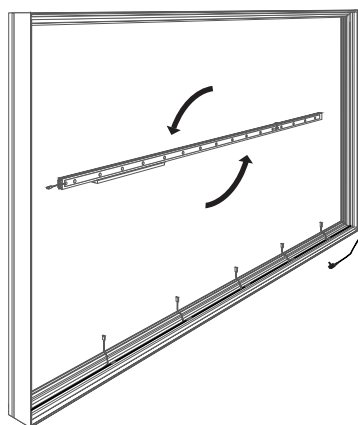
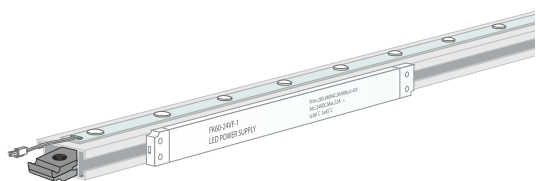

BRITE LED ON STABILIZER
5000-7000k White.
1.2W 24V. 12, 6, 3 or 2 lenses.

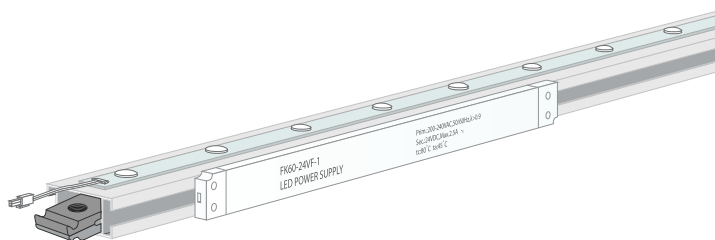

Optional

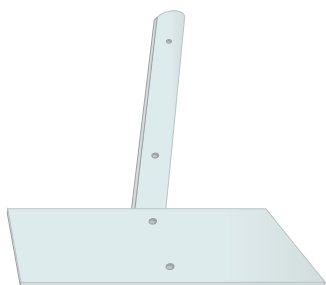

BH0120 / BH0130
Base plate for standing. Material: Steel.

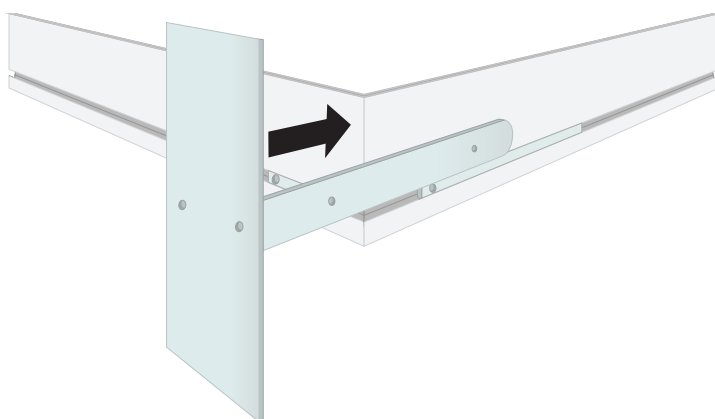

Optional



BH0360
Suspended from ceiling.

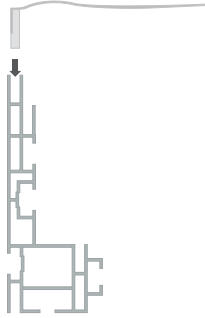
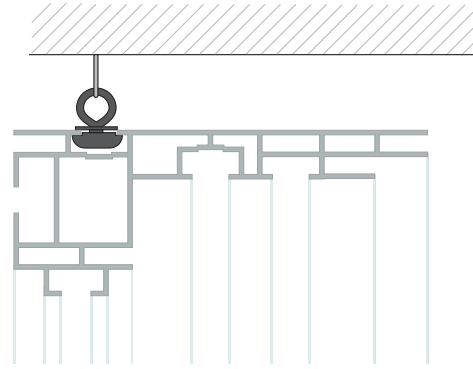

Place the textile print in the frame. Start with the corners and press the silicone strip in the channel.

